



Automation and Monitoring for Aquaponic System Based on NodeMcu

Ahmad Zatnika Purwalaksana^{1,a)}, Indra Hartarto Tambunan^{2,b)},
and Andi Ray Hutauruk²

¹Department of Computer Technology, Faculty of Vocational, Del Institute of Technology, Laguboti, Indonesia

²Department of Electrical Engineering, Faculty of Informatics and Electrical Engineering, Del Institute of Technology, Laguboti, Indonesia

E-mail: ^{a)}ahmad.purwalaksana@del.ac.id

^{b)}indra.tambunan@del.ac.id

Received: 16 September 2021

Revision: 28 September 2021

Accepted: 11 October 2021

Abstract: The increase in the human population, which continues to increase accompanied by the rate of conversion of agricultural land to non-agricultural land is increasingly causing a problem of food supply. Aquaponics is one solution to this problem, but conventional aquaponics treatment must be done manually and will require a lot of time and energy in caring for it if the land is large enough. The implementation of IoT technology can help in the aquaponics treatment. This research aims to create a control and monitoring system for aquaponic cultivation built in a greenhouse. The parameter to be controlled is the water level of the fish pond using an ultrasonic hc-sr04 sensor and a solenoid valve which functions to fill the water in the pond. While the parameters to be monitored are the water level and the pH of the fish pond water. Data from the sensor is sent using the HTTP protocol by the NodeMcu microcontroller to the database via the internet network. The results of this research indicate that the control system has been successfully created where the solenoid valve will turn on when the distance between the ultrasonic sensor and the pool water level is more than 50 cm. The results of water measurements are still fluctuating due to placement of ultrasonic sensors under the water pipe to the fish pond. Meanwhile, the monitoring system will present measurement data in the form of graphs where the data will be updated every 30 minutes.

Keywords: Aquaponic, control system, monitoring, pH sensor, ultrasonic sensor

Abstrak: Peningkatan populasi manusia yang terus meningkat disertai tingkat konversi lahan pertanian ke lahan non pertanian yang semakin besar menyebabkan suatu masalah dibidang penyediaan pangan. Akuaponik merupakan salah satu solusi dari masalah tersebut, namun dalam perawatan akuaponik secara konvensional harus dilakukan secara manual dan akan membutuhkan banyak waktu serta energi dalam merawatnya jika lahannya cukup luas. Implementasi teknologi IoT dapat membantu dalam perawatan akuaponik tersebut. Penelitian ini bertujuan untuk membuat sistem kontrol dan monitoring budidaya akuaponik yang dibangun di dalam Greenhouse. Parameter yang akan dikontrol adalah ketinggian air kolam ikan menggunakan sensor ultrasonik hc-sr04 dan solenoid valve yang berfungsi untuk mengisi air di dalam kolam. Sedangkan parameter yang akan dipantau adalah ketinggian air dan pH air kolam ikan. Data dari sensor dikirim menggunakan protokol HTTP oleh mikrokontroler NodeMcu ke database melalui jaringan internet. Hasil dari penelitian ini menunjukkan bahwa sistem kendali telah berhasil dibuat dimana solenoid valve akan menyala ketika jarak antara sensor ultrasonik dengan ketinggian air kolam lebih dari 50 cm. Hasil pengukuran air masih fluktuatif karena penempatan sensor ultrasonik di bawah pipa air ke kolam ikan. Sedangkan sistem monitoring akan menyajikan data pengukuran dalam bentuk grafik dimana data tersebut akan diperbaharui setiap 30 menit.

Kata kunci: Akuaponik, sistem kontrol, monitoring, sensor pH, sensor ultrasonik,



INTRODUCTION

The human population is increasing every year. It is increasing and is expected to increase from 7.0 billion to 9.5 billion people in the next 40 years [1]. Therefore, the need for food will also increase. The agricultural sector is one of the sources of food production, but now more and more agricultural land where food has been converted to non-agricultural land. An alternative to the problems above is to use an aquaponic system. The application of the aquaponics system can reduce the problem of limited productive land, because this system does not use land and soil for plant cultivation [2].

Aquaponics is a technique for food production that combines traditional methods of hydroponics and aquaculture in one integrated production system [3]. Aquaponic technology in principle, besides saving land and water use, also increases business efficiency through the utilization of nutrients from leftover feed and fish metabolism for aquatic plants and is one of the environmentally-friendly fish farming systems [4]. Aquaponics is the soil-less growing of plants, using fish waste as the food source for plants. It consists of three elements: the plants, the fish and the nitrifying bacteria [5]. Fish waste that contains ammonia cannot be directly absorbed by plants, it must first be converted to nitrate. The conversion process from ammonia to nitrate is in the filter. High levels of ammonia can be toxic to fish. The content of ammonia can be reduced by plants up to 90% of the existing levels, therefore the water is still suitable to be reused as a medium for raising fish [6]. One of the plants that can be used in the aquaponic system is pakcoy [7]. In conventional aquaponic cultivation techniques, several parameters must be considered including the pH of the water and also the availability of water. Fish can survive in various pH levels depending on the species which is best able to survive in the range of 6.5 to 8.5 [8], if the pH value is not ideal, it will have an impact on low growth, disease ranges, and decreased productivity [9]. Therefore, the pH of the water in the system must be within this value range.

Research related to IoT-based aquaponics has been carried out by Haryanto et al. [10] designed a smart aquaponics system that could monitor the degree of acidity, water level, water temperature, and fish feed that were integrated with internet-based mobile applications. In addition, the type of hydroponics used is the Nutrient Film Technique (NFT). In this research, it is not only building a monitoring system of pH levels and pond water levels, but also we will build a control system for filling fish pond water automatically using an NodeMcu that can be accessed anytime via the internet with the type of hydroponics used as a floating raft.

METHODS

This research will be carried out in the IT Del plantation area. The research begins by building a greenhouse that will be used as a place to build the entire aquaponics control and monitoring system. Furthermore, the design of aquaponics cultivation and then designing aquaponic control and monitoring systems.

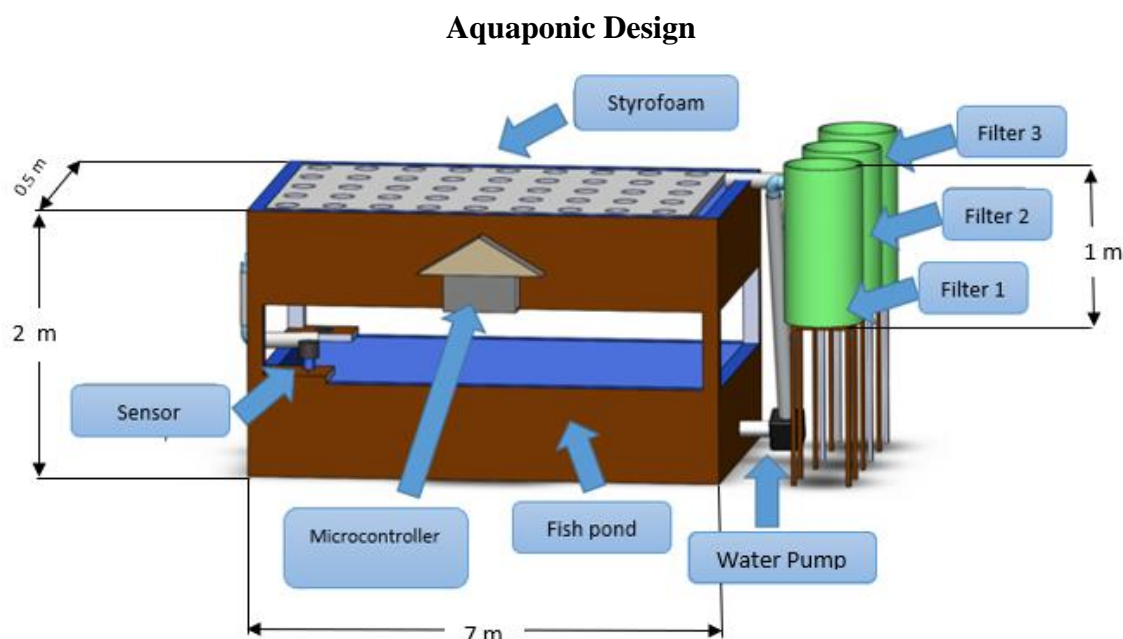

Figure 1. Design of aquaponic cultivation.

An aquaponic design consisting of a pond for fish cultivation, a hydroponic pond with a floating raft system, a water filter, a water pump, a microcontroller, and several sensors as shown in Figure 3. The source of plant nutrition in this aquaponic system is nitrate which is converted from ammonia produced from fish. The total ammonia content consists of the content of ammonium (NH_4^+) which can be ionized and free ammonia (NH_3) is not ionized [11]. To convert the ammonia to nitrate, a filter is needed. In this research, there are two types of filters used, biological filters and mechanical filters as used in research conducted by Abentin Estim et. al. [12]. The design of filters which were used in this research is shown in Figure 1.

Filter 1 is a mechanical filter that separates large fish manure to settle at the bottom of the filter, then filter 2 and 3 which are biological filters that function to convert ammonia into nitrate so that it can be absorbed by plants. Filter 2 is filled with charcoal while filter 3 is filled with bio balls. The placement of ultrasonic and pH sensors in an aquaponic system is shown in Figure 2.

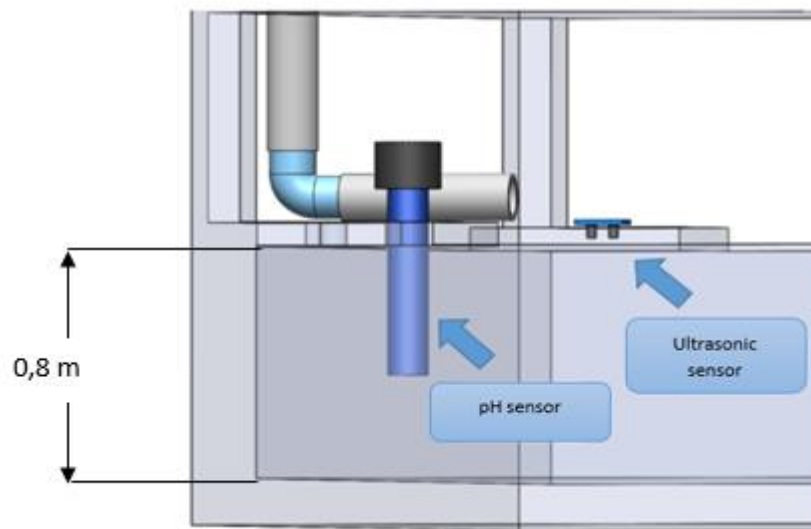

Figure 2. Placement of ultrasonic and pH sensor

The ultrasonic sensor is placed on the water supply pipe in the fish pond and the pH sensor will be immersed in the fish pond. The measurement that will be carried out by the ultrasonic sensor is the distance between the sensor and the water surface. The height of the fish pond is 0.8 m where the water to be regulated with a maximum height is 30 cm or the distance between the sensor and the maximum water surface is 50 cm.

Control and monitoring system design

Control and monitoring system using NodeMcu microcontroller, ultrasonic sensor, pH, and Solenoid valve which is implemented in aquaponics cultivation. The overall design of the system is shown in Figure 3.

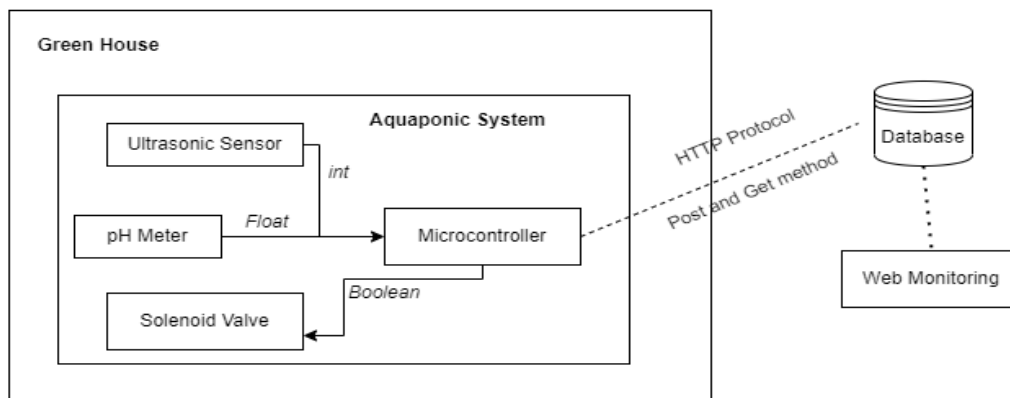

Figure 3. Design of control and monitoring system.

Figure 3 shows that the ultrasonic sensor will send distance data in integer format to the microcontroller, while the pH sensor will send water pH data in float format. Next, the microcontroller will send boolean data that is true or false to the solenoid valve to turn it on or off depending on the water distance measurement value. Distance and pH data are sent using the HTTP protocol over the internet by the microcontroller to the database. The database will store the data sent and then the data can be viewed on the web which is presented in the form of real-time graphs.

The condition of the water distance set in the control system can be seen in Figure 4.

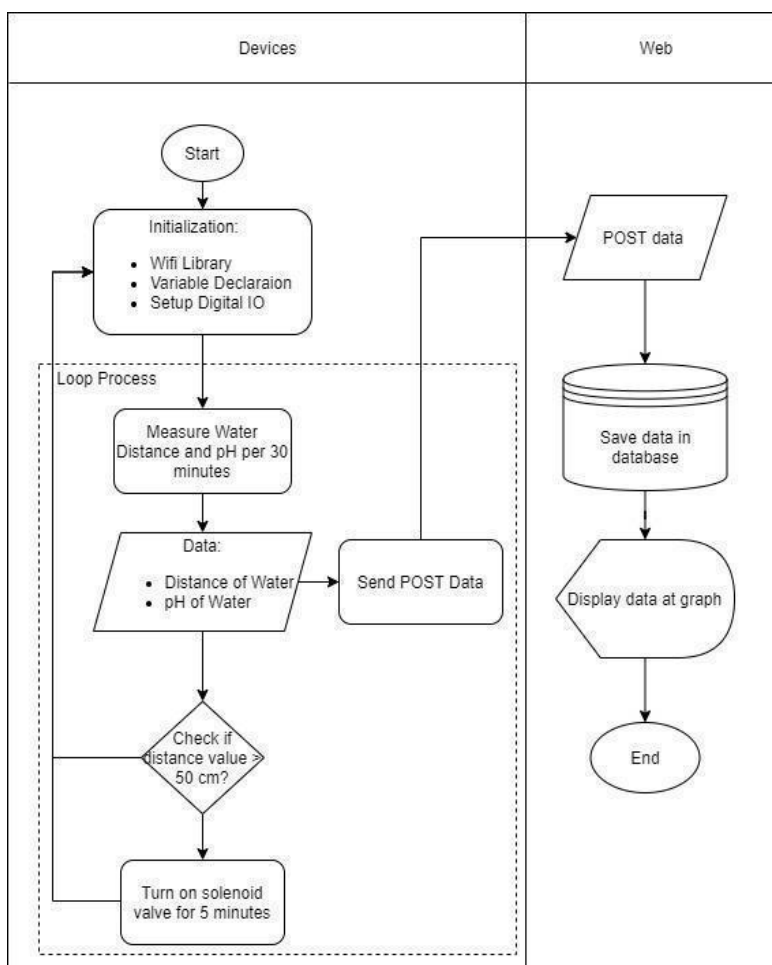

Figure 4. Flowchart of system.

First, the microcontroller will do the initiation in the form of setting up the wifi library, digital pin IO and variable declaration, then enter the loop process in which there is a process of measuring distance and pH. After the data is obtained, the data is sent using the post method via the HTTP protocol to the database. Because the changes in measurement data from pool water level and pH levels are not so fast, the data is sent every 30 minutes. The data of distance between sensor and water surface will be checked whether the value is more than 50 cm. If the value is more than 50 cm, it will turn on the solenoid valve to fill the pool water. The last data from the database will be displayed on the web.

RESULT AND DISCUSSION

In this study, a greenhouse was built in which aquaponic cultivation was built. This aquaponic cultivation consists of a hydroponic pond and a fish pond installed with a control and monitoring system. The control system is made to fill pool water automatically using ultrasonic sensors and solenoid valves, while the monitoring system will display water level and pH data obtained from ultrasonic sensor measurements and pH meters.

The tests that will be carried out include measuring ultrasonic and pH sensors, as well as testing control and monitoring systems.

System Implementation

The greenhouse is built on an area of 5 x 10 meters with the mainframe made of bamboo. The roof of the greenhouse uses UV plastic and the walls using paranet. Inside the green house, an aquaponics system will be built with a fish pond volume of 2 x 7 x 0.8 meters as shown in Figure 5. The fish to be cultivated is tilapia.



Figure 5. Implementation of a fish pond.

As for the hydroponic system, it will be installed above a fish pond with a volume of 0,5 x 7 x 0.2 meters as shown in Figure 6.



Figure 6. Implementation of Hydroponic pool.

In an aquaponics system, the ammonia contained in fish manure must be converted to nitrate so that it can be absorbed by plants where the conversion is carried out in a filter as shown in Figure 7.

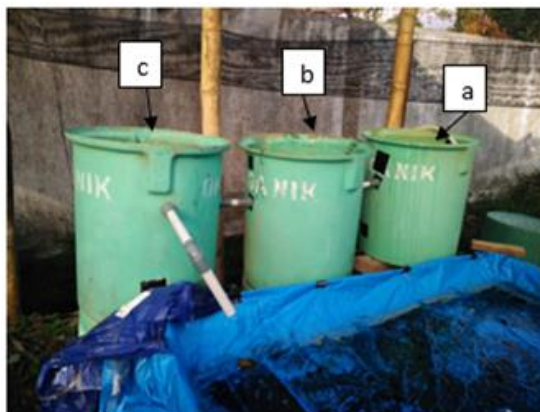

Figure 7. Implementation of filters in aquaponic cultivation.

Filter a in Figure 7 is a mechanical filter that separates fish manure by a deposition process while filter b and filter c are biological filters that will convert ammonia to nitrate where filter b contains charcoal and filter c contains bio balls.

The sensor used in the water filling control system is the ultrasonic sensor HC-SR04 which functions to measure the height of the pool water, while the actuator used is a solenoid valve that functions to drain water into the pool for 1 minute if the height value is above 50 cm. The placement of sensors and actuators is shown in Figure 8.



Figure 8. Ultrasonic sensor and solenoid valve at pond inlet.

Measurement of Sensors

Distance measurements by ultrasonic sensors are tested by comparing it with the results of measurements by a ruler. Result of the measurement is shown at Figure 9.

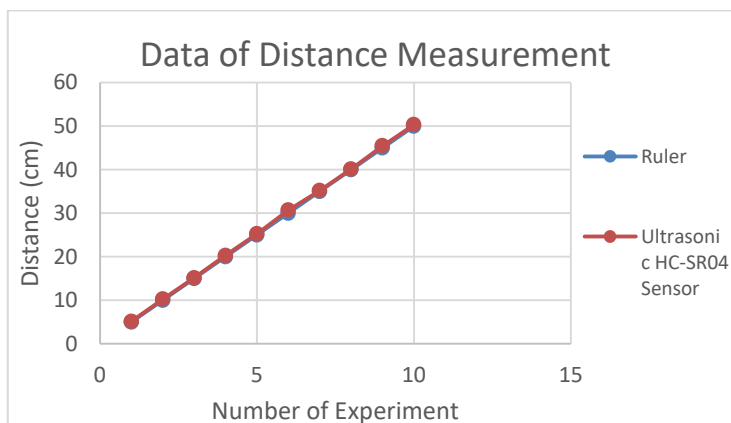

Figure 9. Graph of distance measurement

The comparison of the measurement results will determine the error value with the following equation:

$$\% \text{ error} = \frac{|\text{accepted value} - \text{experimental value}|}{\text{accepted value}} \quad (1)$$

Calculation of the measurement error value between ultrasonic sensors and rulers are shown in Table 1.

Table 1. Mean error from measurement of ultrasonic sensor.

No	Result of Measurement		Delta (cm)	Error (%)
	Ruler (cm)	Ultrasonic HC-SR04 Sensor (cm)		
1	5	5,12	0,12	2,4
2	10	10,25	0,1	1
3	15	15,14	0,14	0,933333
4	20	20,29	0,1	0,5
5	25	25,25	0,1	0,4
6	30	30,7	0,7	2,333333
7	35	35,17	0,17	0,485714
8	40	40,14	0,14	0,35
9	45	45,46	0,46	1,022222
10	50	50,31	0,31	0,62
Mean Error (%)				1,00446

Table 1 explains the error value of the ultrasonic sensor measurement hc-sr04 which is compared with the results of the ruler measurement, the minimum value is 0.2%, the maximum is 2.4%, and the average value is 1.004%.

pH level measurements by modul pH meter 4502C is tested by comparing it with the results of measurements by digital pH meter. Result of the measurement is shown at Figure 10.

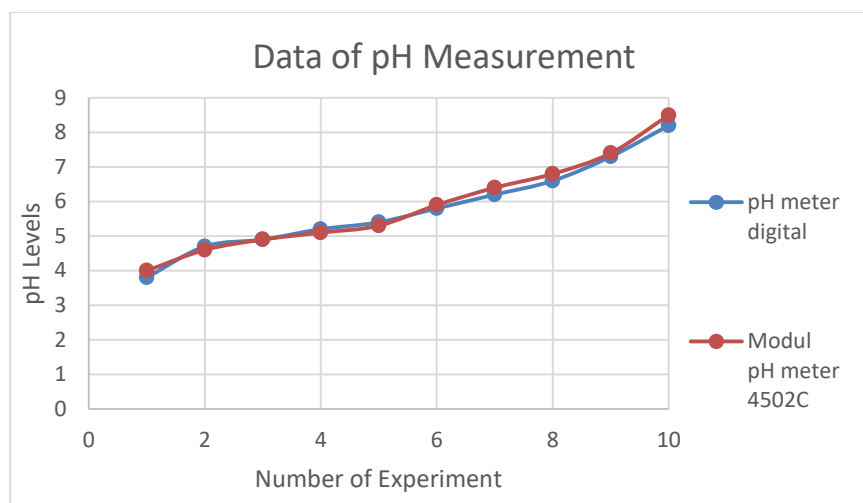

Figure 10. Graph of pH levels measurement

Calculation of the measurement error value between pH 4502C and digital pH meter are shown in Table 2. Table 2 explains that the error value of the pH measurement compared to the digital pH meter measurement results obtained that the minimum value is 0%, the maximum is 5.26%, and the average value is 2.41%.

Table 2. Mean error from measurement of pH sensor.

No	Result of Measurement		Delta	Error (%)
	Digital pH meter	Modul pH meter 4502C		
1	3,8	4	0,2	5,263158
2	4,7	4,6	0,1	2,12766
3	4,9	4,9	0	0
4	5,2	5,1	0,1	1,923077
5	5,4	5,3	0,1	1,851852
6	5,8	5,9	0,1	1,724138
7	6,2	6,4	0,2	3,225806
8	6,6	6,8	0,2	3,030303
9	7,3	7,4	0,1	1,369863
10	8,2	8,5	0,3	3,658537
Mean Error (%)				2,417439

Monitoring System

The results of measuring water level data and water pH that have been carried out by sensors will then be sent to the database via the HTTP protocol using the Post method. The measurement data from the ultrasonic sensor hc-sr01 and the pH 4502C sensor are displayed in graphical form on a Web in real-time as shown in Figure 11.

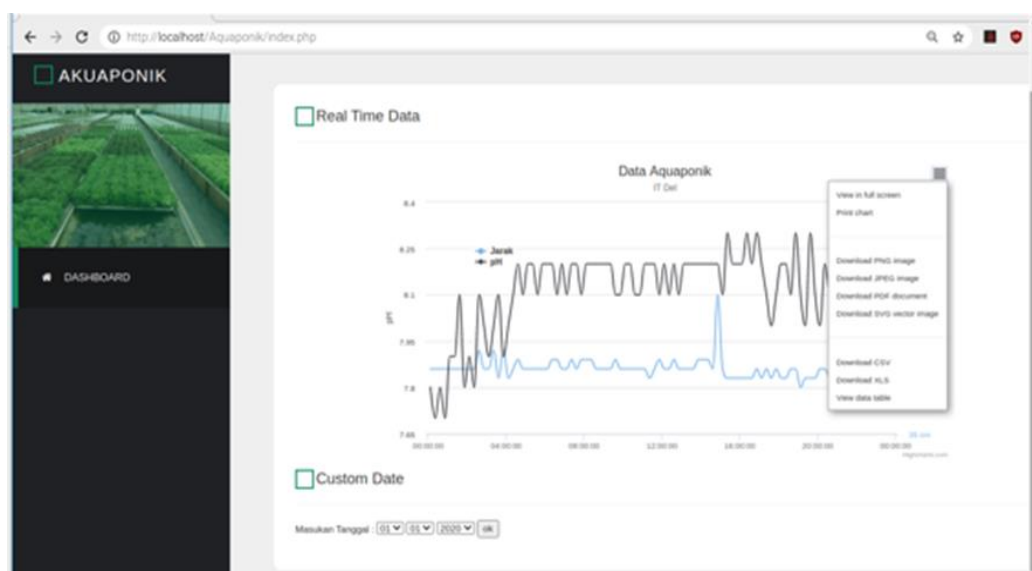
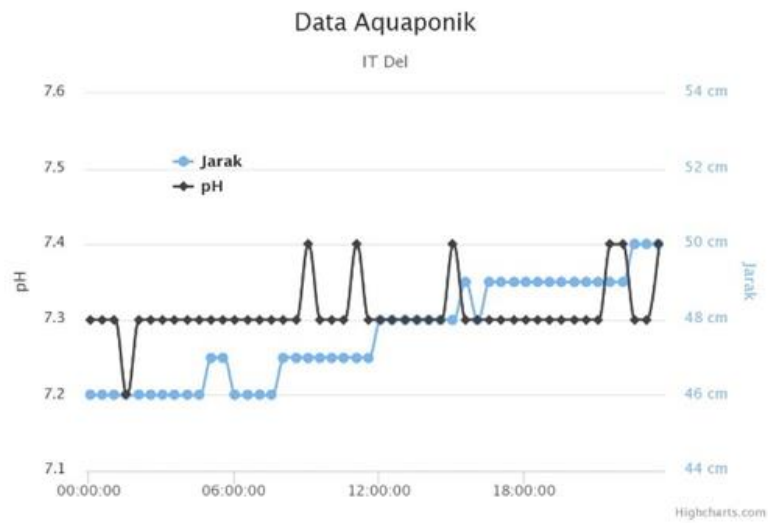

Figure 11. Web monitoring for aquaponic.

Figure 11 explains that the monitoring web display presents water level measurement data and water pH levels in a graph where the y-axis is the value of the measurement and the x-axis is time. In the graph, there are two colors to make it easier for users to distinguish between water level and pH data where the water level data is shown on the graph with a blue line, while for water pH data it is shown with a black line. In addition to real-time data, there is also a feature to view previous data by selecting a date in the "Custom Date" section. In the graphics section, there is a feature to download the data in several formats, namely PNG, JPEG, SVG, CSV, and XLS.

Control System

The results of measuring water distance and water pH for several days are shown in Figure 12 where the blue line is the water pH data and the black line is the pool water distance data.



(a)

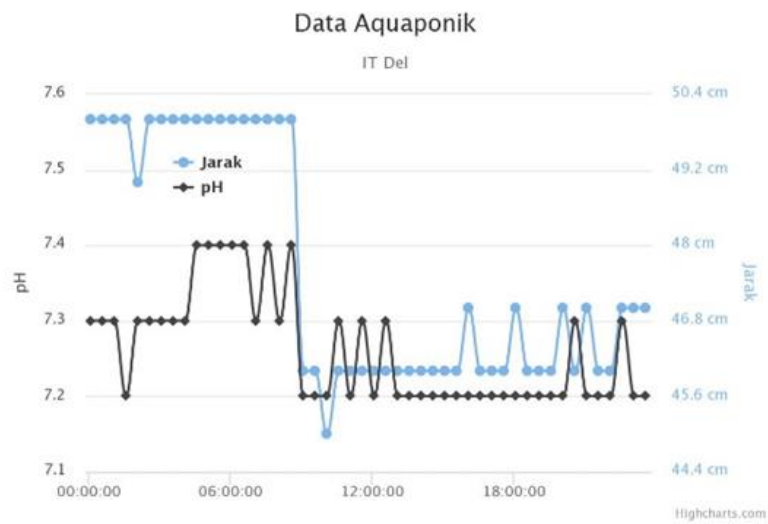

(b)

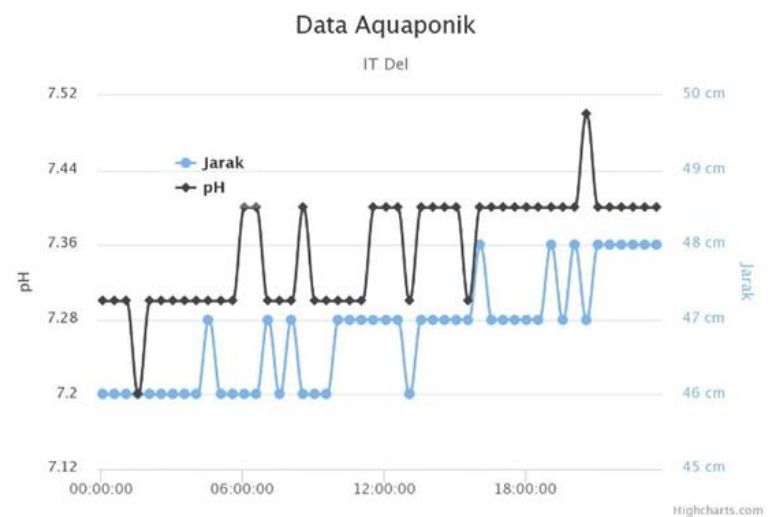

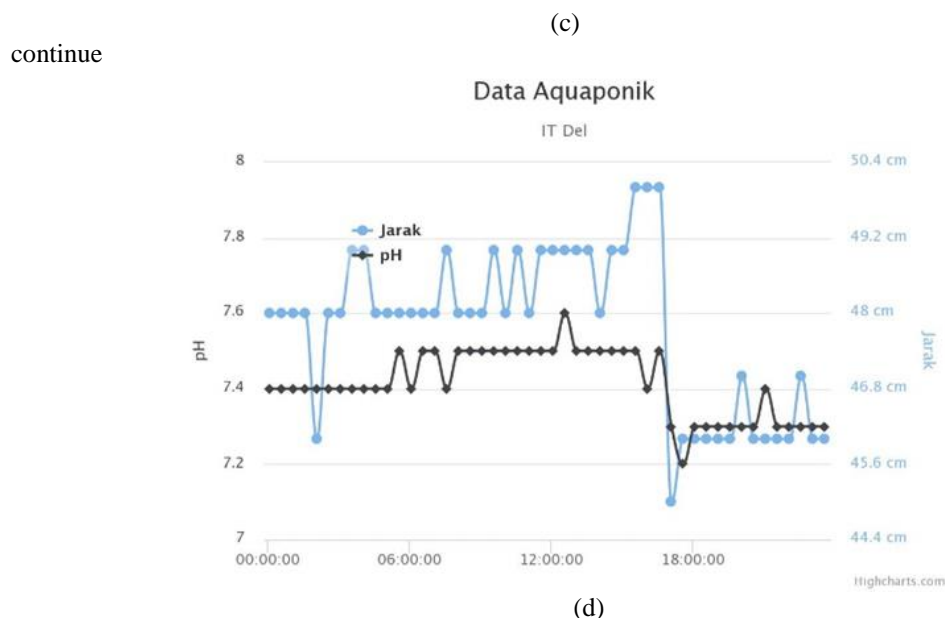

Figure 12. Monitoring data on water distance and pH on date (a). May 19, 2021, (b). 20 May 2021, (c) 21 May 2021, and (d). May 22, 2021.

Figure 12 (a) and (b) we can see that the water distance and pH values have increased. This increase in water distance indicates that there is a reduction in the volume of fish pond water which can be caused by evaporation and absorption by plants to grow, while the increase in pH is caused by the accumulation of additional ammonia produced from fish waste. We can see that in Figure 12 (b) when the water distance is greater than 50 cm then the data in the next 30 minutes changes to 46 cm, this is because the system turns on the solenoid valve to fill the water in the fish pond so that the distance between the water surface and the sensor ultrasonic increase. Likewise for the pH value of the water decreases when the solenoid valve is active because the water entering the fish pond has a pH value of around 6.8. The pattern is repeated in Figures 12 (c) and (d).

CONCLUSIONS

The fish pond water level control system, as well as a monitoring system for the height and pH of fish pond water in aquaculture, have been successfully created where the sensor used to measure the water level is the ultrasonic sensor hc-sr04 and the sensor used to measure the pH level is the pH 4502C sensor. The average measurement error of the ultrasonic sensor is 1.03% while for the pH sensor it is 2.41%. The monitoring system is made by displaying real-time data from measurements made by sensors every 30 minutes and presented in a graph on the Web. The pool water level control system is carried out by turning on the solenoid valve to fill the pool water for 5 minutes when the water distance value is more than 50 cm.

ACKNOWLEDGEMENT

This research activity was carried out with a lot of support from several units. Thanks to the Institut Teknologi Del for the support, facilities and funding that has been provided for this research.

REFERENCE

- [1] Sahara Forest Project, "Sahara Forest Project Website," Sahara For. Proj., 2021, [Online]. Available: <https://www.saharaforestproject.com/>.
- [2] H. Susanto and R. Sutarmanto, *Budidaya Ikan Gurami*. 2010.
- [3] A. Kurian Oommen, A. Saji, S. Joseph, and B. P. Kuriakose, "Automated Water Quality Monitoring System for Aquaponics," *Int. Res. J. Eng. Technol.*, vol. 7832, no. May, pp. 7832–7841, 2008, [Online]. Available: www.irjet.net.

- [4] T. H. dan E. L. Irfan Zidni, "Pengaruh Padat Tebar Terhadap Pertumbuhan Benih Lele Sangkuriang (*Clarias gariepinus*) dalam Sistem Akuaponik," *J. Perikan. Kelaut.*, vol. 4, no. 4, pp. 315–324, 2013.
- [5] C. F. Sace and K. M. Fitzsimmons, "Vegetable production in a recirculating aquaponic system using Nile tilapia (*Oreochromis niloticus*) with and without freshwater prawn (*Macrobrachium rosenbergii*)," *Acad. J. Agric. Res.*, vol. 1, no. 12, pp. 236–250, 2013, [Online]. Available: <http://dx.doi.org/10.15413/ajar.2013.0138>.
- [6] H. T. Nhan, N. T. Tai, P. T. Liem, V. N. Ut, and H. Ako, "Effects of different stocking densities on growth performance of Asian swamp eel *Monopterus albus*, water quality and plant growth of watercress *Nasturtium officinale* in an aquaponic recirculating system," *Aquaculture*, vol. 503, pp. 96–104, 2019, doi: 10.1016/j.aquaculture.2018.12.067.
- [7] A. E. Munawarawanti, S. B. A. Omar, R. Syamsuddin, S. A. Syaiful, F. Ulfa, and A. Dachlan, "The effectiveness of biofilter and density of different stocking in aquaponic resirculation systems in the integration of tilapia (*Oreochromis niloticus* L.) and pakchoy plants (*Brassica rapa* L.)," *IOP Conf. Ser. Earth Environ. Sci.*, vol. 486, no. 1, 2020, doi: 10.1088/1755-1315/486/1/012137.
- [8] A. Graber and R. Junge, "Aquaponic Systems: Nutrient recycling from fish wastewater by vegetable production," *Desalination*, vol. 246, no. 1–3, pp. 147–156, 2009, doi: 10.1016/j.desal.2008.03.048.
- [9] R. Rahmat, M. Tanjung, and I. Zidni, "Effect of difference filter media on Recirculating Aquaculture System (RAS) on tilapia (*Oreochromis niloticus*) production performance," *World Sci. News*, vol. 118, no. January, pp. 194–208, 2019.
- [10] Haryanto, M. Ulum, A. F. Ibadillah, R. Alfita, K. Aji, and R. Rizkyandi, "Smart aquaponic system based Internet of Things (IoT)," *J. Phys. Conf. Ser.*, vol. 1211, no. 1, 2019, doi: 10.1088/1742-6596/1211/1/012047.
- [11] R. Crab, T. Defoirdt, P. Bossier, and W. Verstraete, "Biofloc technology in aquaculture: Beneficial effects and future challenges," *Aquaculture*, vol. 356–357, pp. 351–356, 2012, doi: 10.1016/j.aquaculture.2012.04.046.
- [12] A. Estim, S. Saufie, and S. Mustafa, "Water quality remediation using aquaponics sub-systems as biological and mechanical filters in aquaculture," *J. Water Process Eng.*, vol. 30, 2019, doi: 10.1016/j.jwpe.2018.02.001.